

1541 S. County Road 450 E.  
Greencastle, IN 46135

1250 Gallon Septic

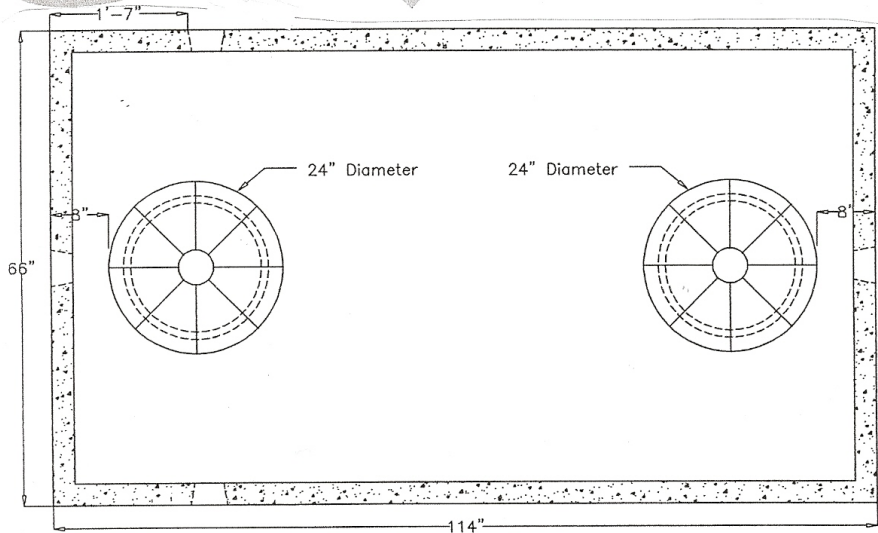

TOP VIEW

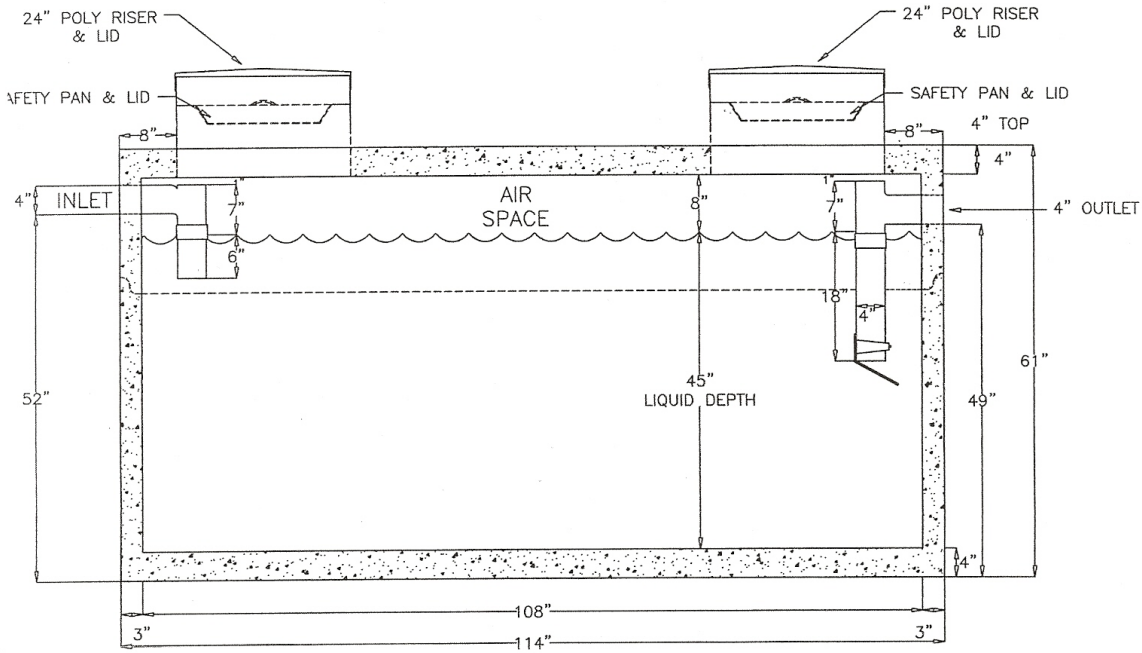

SIDE VIEW

Phone: 765-653-6533 • Fax: 765-653-4007  
www.cashconcrete.com